

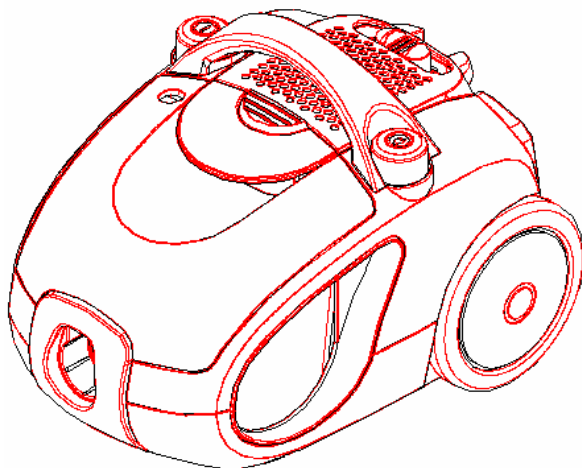

designed for life



**VACUUM CLEANER
SC11052**



USER INSTRUCTIONS



GUARANTEE

This product is guaranteed for 2 years from the date of original purchase. If any defect arises due to faulty materials or workmanship, the unit will, either be repaired, replaced or refunded at our discretion.

The following conditions apply:

- ❑ The product must be returned to the retailer with original proof of purchase.
- ❑ The product must be installed and used in accordance with the instructions contained in this user instruction guide.
- ❑ It must be used only for domestic purposes.
- ❑ It does not cover wear and tear, damage, misuse or consumable parts.
- ❑ The supplier has no responsibility for incidental or consequential loss or damage.
- ❑ Valid in the UK & Eire only.
- ❑ Valid only if purchased from the SDHS Group

Technical Specification:

Power supply:	220V-240V AC. 50Hz
Power Consumption:	1600 W Max
Model number:	SC11052
Protection:	Class II



SDHS Group
L70 1AB
Box MPRC8

Swan Vacuum Helpline. Please Call 01733 404703
Swan Vacuum Spare Parts. Please Call 01733 404709
Calling from outside the UK Please Call - 00 44 1733 404703

IMPORTANT SAFETY INSTRUCTIONS

READ THIS SECTION TO BE AWARE OF THE RISK OF PERSONAL INJURY, DAMAGE TO PROPERTY, ELECTRIC SHOCK & FIRE.

1. This appliance is not intended for use by persons (including children) with reduced physical, sensory or mental capabilities, or lack of experience and knowledge, unless they have been given supervision or instruction concerning use of the appliances by a person responsible for their safety.
2. Children should be supervised to ensure they do not play with the appliance.
3. Never vacuum wet surfaces, pick up wet objects or use in wet conditions.
4. Always disconnect the vacuum from the electrical supply before attempting any servicing or maintenance. Never leave the vacuum unattended when plugged in.
5. Do not vacuum anything that is burning or smoking, such as cigarettes matches, or hot ashes.
6. Do not use the vacuum cleaner to pick-up large objects that could damage or cause a blockage.
7. Do not use the vacuum to pick up builders rubble, sand, plaster dust etc.
8. This vacuum cleaner is for domestic use only. Industrial or commercial use invalidates the warranty.
9. Do not use without a dust bag/bin and filter in place.
10. Use extra care when cleaning on stairs.
11. Keep hair, loose clothing, fingers and all parts of the body away from openings and moving parts.

Safety Alerts:

1. To reduce the risk of electric shock, do not use outdoors or on wet surfaces.
2. Use only as described in this manual.
3. Do not use with a damaged cord or plug.
4. Do not run the vacuum cleaner over the cord. Keep the cord away from heated surfaces.
5. Do not unplug by pulling on the cord. To unplug, grasp the plug, not the cord.
6. Do not handle the plug or the vacuum cleaner with wet hands.
7. Turn off all controls before unplugging.

This vacuum cleaner is equipped with a plug and a cable, which rolls up automatically. If either becomes damaged, a qualified service agent must repair both the plug and cable.

Electrical Safety

Before switching on, make sure that the voltage of your electricity supply is the same as that indicated on the rating plate. This product is designed to operate on 220 – 240V AC, 50Hz. Connection to any other power source may damage the unit.

This product may be fitted with a non – rewirable plug. If it is necessary to change the fuse in the plug, the fuse cover must be refitted. If the fuse cover becomes lost or damaged, the plug must not be used until a suitable replacement obtained.

If the plug has to be changed because it is not suitable for your socket, or becomes damaged in any way, it should be cut off and an appropriate plug fitted following the wiring instructions below. This should be carried out by a qualified electrician. The plug removed must be disposed of safely, as insertion into a 13 Amp socket is likely to cause an electrical hazard.

IMPORTANT – THIS IS A CLASS II APPLIANCE AND DOES NOT REQUIRE AN EARTH CONNECTION.

Wiring Instructions

The wires in this mains lead are colored in accordance with the following code:

Blue = Neutral

Brown = Live

As the colours of the wires in the mains lead of this appliance may not correspond with the coloured markings identifying the terminals in your plug, proceed as follows (refer to the plug wiring diagram).

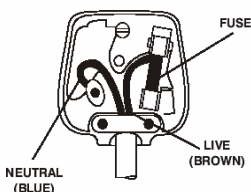

- The wire which is coloured **BLUE** must be connected to the terminal which is marked with the letter **N** or coloured Black.
- The wire which is coloured **BROWN** must be connected to the terminal which is marked with the letter **L** or coloured Red.

If a 13Amp (BS1363) plug is used, a 13Amp (BS1362) fuse must be fitted, or if any other type of plug is used, a 13Amp fuse must be fitted, either in the plug or adaptor, or on the Distribution Board.

Description:

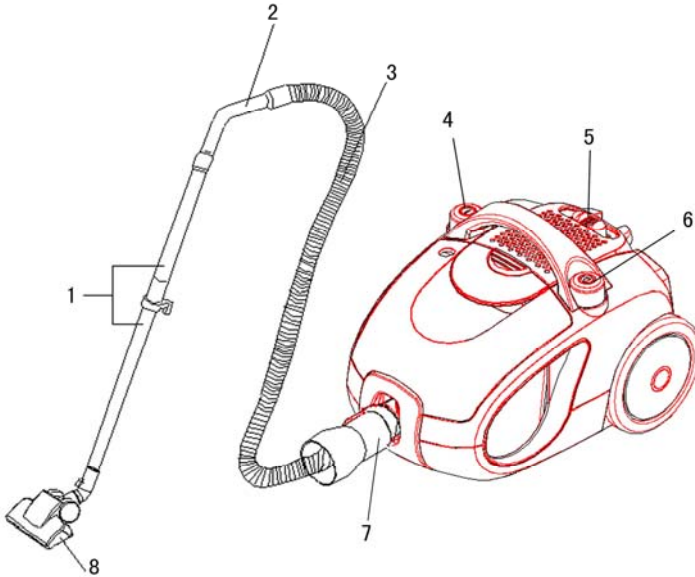

9. Turbo brush

The turbo brush is a rotating brush driven by the suction of the vacuum cleaner.

Brushing agitates the surface and releases more dirt than suction power alone.

The brush action is also more effective in picking up pet hairs.

Vacuum Parts Description	
1. Extension Tube	6. Cable Rewind Button
2. Handle	7. Hose Inlet
3. Flexible Hose	8. Floor Brush
4. On / Off Switch	9. Turbo Brush
5. Power Slide Regulator	

ASSEMBLY INSTRUCTION:

Always remove the plug from the power socket before fitting or removing accessories!

1. Fitting and removing the flexible hose.

Fitting:

Insert the flexible hose into the suction hole. Push until it clicks and locks into position.

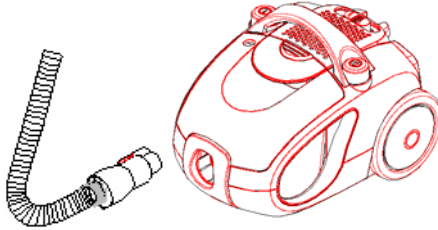

Removing:

Press the button to release and pull the hose from the suction inlet.

2. Fitting the extension tubes, floor head and accessories.

a. Fit the extension tube to the hose nozzle.

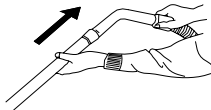

b. Fit the floor brush or turbo brush to the chrome telescopic tube.

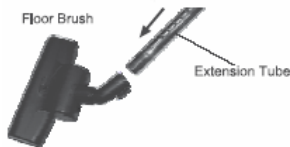

c. The chrome telescopic tube can be extended by pushing the release button and pulling the tube.



- d. Floor head - ideal for the daily cleaning on carpets and hard floors.

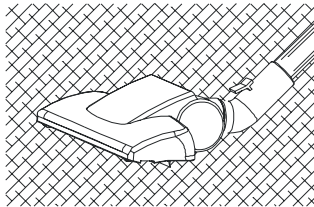
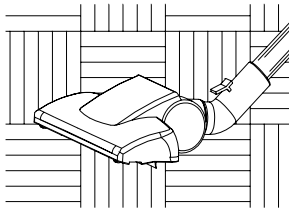

Cleans on the carpet

For use on hard floors ensure the floor head bristles are extended.

- e. Crevice tool - for radiators, corners, baseboards and between cushions.

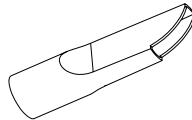

- f. Soft brush and upholstery attachment – ideal for fabrics, picture frames and cleaning the sofa.

To use the upholstery tool slide the brush head off the attachment.

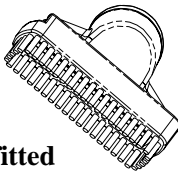

Brush head fitted

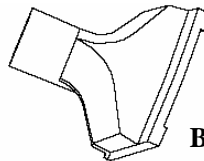

Brush head removed

Note: The crevice and soft brush attachments are stored at the rear of the vacuum.

INSTRUCTIONS FOR USE

1. Unwind a sufficient length of cable. A yellow mark on the power cable shows the ideal cable length. **Do not** extend the cable beyond the red mark.

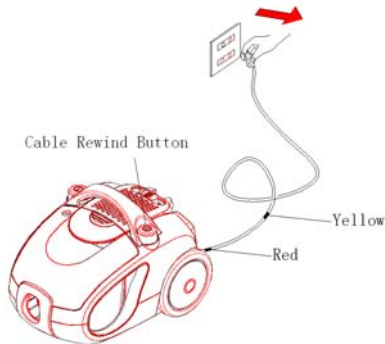

2. You should plug the appliance into a 220V-240V SUPPLY ONLY.

Before connecting to the power source, make sure the dust-bin; filter and accessories are fitted correctly. **Do not operate without dust-bin or filters in place.

3. Press the ON/OFF power switch to start vacuuming.

4. The SC11052 vacuum has a sliding power regulator which allows easier suction control when vacuuming.

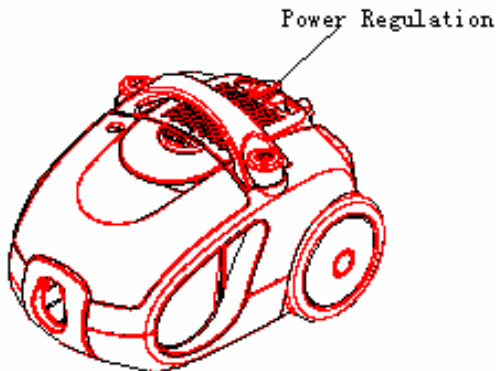

5. Thermal cut out:

This vacuum is fitted with a thermal cut out device, which protects the vacuum if the motor should overheat. If the cleaner suddenly stops, please check the following:

- a. Switch off the cleaner and unplug from the power supply.
- b. Check the cause of overheating; blocked hose, clogged filter, full dust-bin etc.
- c. Clear the blockage, clean / replace the filter or empty the dust-bin as necessary.
- d. Wait 30 – 60 minutes, the thermal device will reset automatically

Cord Rewind: to rewind the power cord, press the rewind button with one hand and guide the cord with the other hand to ensure that it doesn't whip causing damage.

Swan Vacuum Help-line Call 01733 404703
Swan Vacuum Spare Parts Call 01733 404709
Calling from outside the UK Please Call - 00 44 1733 404703

MAINTENANCE

Removing rubbish from the dust-bin

- Always unplug the vacuum before any maintenance.
- Always operate the cleaner with the dust-bin installed.
- The dust-bin must be emptied each time the dust full indicator turns red, whilst the vacuum is operating at maximum power and the nozzle is raised from the floor.

1. Before emptying the dust-bin, remove the hose from the hose inlet.

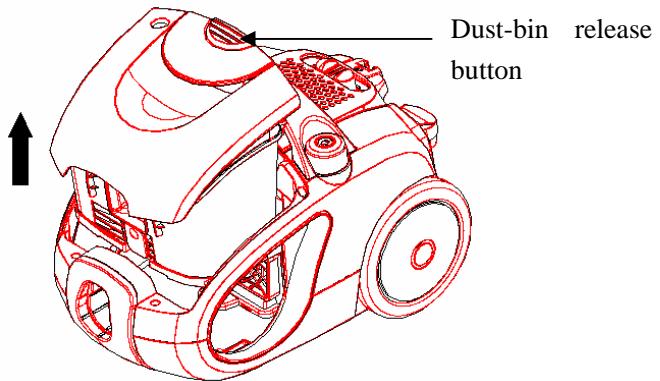

2. Press the release button and lift out the dust-bin.

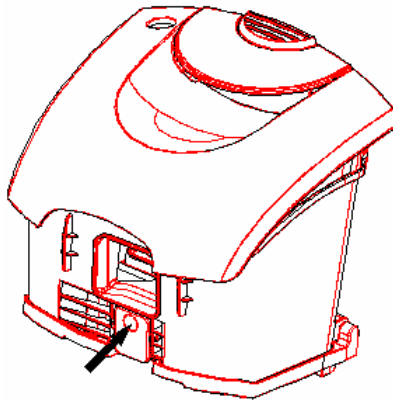

3. Release the dust-bin lock.

4. Open the dust-bin trap door and empty the rubbish.

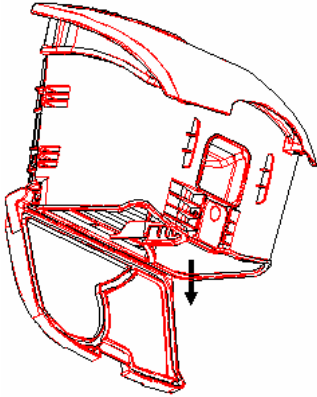

5. Whilst emptying the dust-bin, check the **dust cone** is clear. The dust cone can be accessed when the dust-bin trap door is open. Grip the dust cone at its base and twist anti-clockwise to remove. Brush clean and replace.

Please ensure when refitting, that it is located correctly and that it locks into position before closing the dust-bin trap door.

6. Replace the dust-bin subassembly and lock back in place.

Cleaning / Changing the Hepa inlet filter and foam filter:

- Both filters should be cleaned at least twice a year or when it becomes visibly solid. This filter can be washed in clean warm water.
- Always operate the cleaner with the filters installed, otherwise reduced suction or motor damage may occur.
- Disconnect from the electrical outlet before cleaning the filters.
- Do not use a washing machine to wash / rinse the filters.
- Do not use a hair drier to dry it.
- Allow at least 24 hrs to air dry before refitting the filters.

1. Take out the HEPA filter assembly.

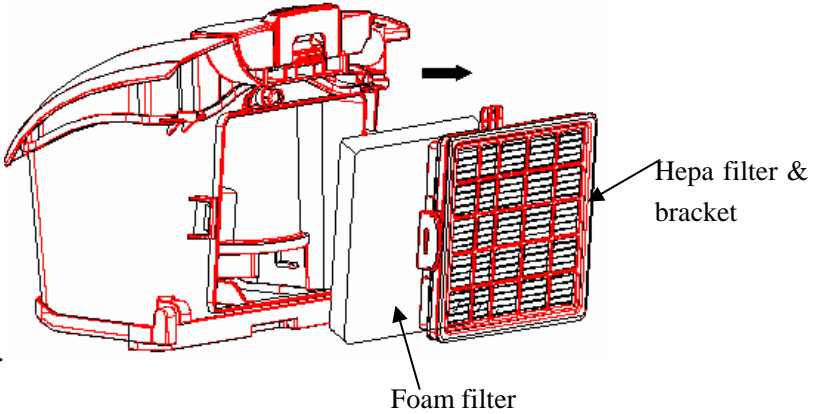

2. Rinse the Hepa filter and bracket in warm water and allow to dry completely before refitting.

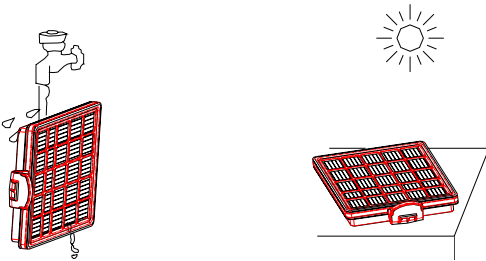

3. Rinse the sponge filter in warm water and allow to dry completely before refitting.

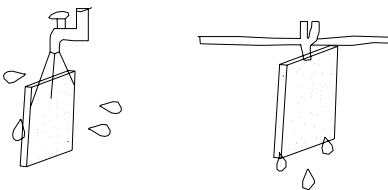

Changing the Anti-microbial Exhaust filter

1. Unclip the exhaust filter cover, doing this will allow access to the filter.
2. With the filter cover removed take out the filter.
3. Replace the filter with a clean new one.
4. Close the cover.

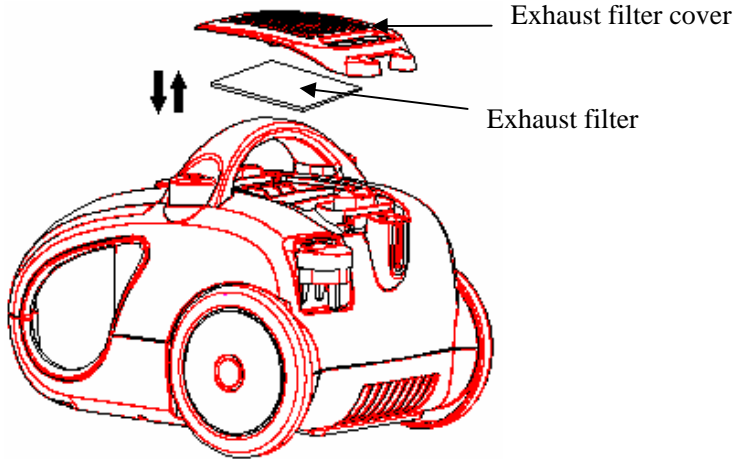

SWAN VACUUM HELP-LINE: PLEASE CALL 01733 404703
SWAN VACUUM SPARE PARTS: PLEASE CALL 01733 404709
Calling from outside the UK Please Call - 00 44 1733 404703

If your appliance should fail, please check the following:

- * Make sure the mains plug is correctly fitted in the socket.
- * Check the fuse in the plug.
- * Try another socket.
- * In case the thermal cut out has tripped, allow 30 – 60 minutes for the cutout device to reset. Please check for blockages in the hose, filters and dust-bag.

Service

- If the vacuum power cord has been damaged in any way, do not use the vacuum cleaner. The vacuum cleaner must be repaired by a qualified service agent.
- If you have any technical problems with your vacuum cleaner, please call the Swan helpline: 01733 404703.

SPARE PARTS LIST

SC11050 /01	Hose & Nozzle
SC11050 /02	Floor Head
SC11050 /03	Chrome telescopic tube
SC11050 /04	Crevice tool
SC11050 /05	Small Brush / Upholstery tool
SC11051 /06	Turbo brush
SC11050 /07	Dust cone (see page 10)
SC11052 /51	Filter Kit

SWAN VACUUM HELP-LINE: PLEASE CALL 01733 404703

SWAN VACUUM SPARE PARTS: PLEASE CALL 01733 404709

Calling from outside the UK Please Call - 00 44 1733 404703

WASTE ELECTRICAL RECYCLING

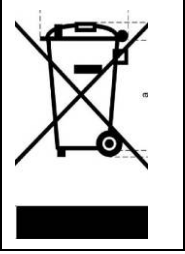

This symbol indicates that this product is classed as Electrical or Electronic Equipment and should not be disposed of with other household waste.

The Waste Electrical and Electronic Equipment (WEEE) Directive has been introduced across the European Union:

- to recycle waste electrical products using the best available recovery and recycling techniques in order to minimise the impact on the environment
- to treat any hazardous substances and
- to avoid increasing landfill.

WEEE product should be disposed of by handing it over at a designated collection point.

For more information about where you can drop off your waste product for recycling please contact your local authority.

