



designed for life



**VACUUM CLEANER**



**INSTRUCTION MANUAL**

**Model: SU3021**



## **GUARANTEE**

This product is guaranteed for 2 years from the date of original purchase. If any defect arises due to faulty materials or workmanship, the unit will, either be repaired, replaced or refunded at our discretion.

### **The following conditions apply:**

- ❑ The product must be returned to the retailer with original proof of purchase.
- ❑ The product must be installed and used in accordance with the instructions contained in this user instruction guide.
- ❑ It must be used only for domestic purposes.
- ❑ It does not cover wear and tear, damage, misuse or consumable parts.
- ❑ The supplier has no responsibility for incidental or consequential loss or damage.
- ❑ Valid in the UK & Eire only.
- ❑ Valid only if purchased from the SDHS Group.

### **Technical Specification:**

Power supply:	220V-240V AC. 50Hz
Power Consumption:	1800 Watts Max
Model number:	SU3021
Protection:	Class II



SDHS Group  
L70 1AB  
Box MPRC 8

**Swan Vacuum Helpline. Please Call 01733 404703**  
**Swan Vacuum Spare Parts. Please Call 01733 404709**  
**Calling from outside the UK please call - 00 44 1733 404703**

# IMPORTANT SAFETY INSTRUCTIONS

When using your **Cyclonic Upright Vacuum**, the following basic safety precautions should be observed:

1. Never vacuum wet surfaces, pick up wet objects or use in wet conditions.
2. Always disconnect the vacuum from the electrical supply before attempting any maintenance.
3. Do not vacuum anything that is burning or smoking, such as cigarettes, matches, or hot ashes.
4. Do not use the vacuum to pick-up large objects that could, damage or cause a blockage.
5. Do not use the vacuum to pick up builders rubble, sand, plaster dust etc.
6. This vacuum cleaner is for domestic use only. Industrial or commercial use invalidates the warranty.
7. Do not let children use the vacuum cleaner unattended.
8. Do not use without a dust bag/bin and filter in place.
9. Use extra care when cleaning on stairs.
10. Always ensure the vacuum height setting is set in the tools position when using on stairs. Take extra care not to allow the vacuum to tilt and the beater bar make contact with the carpet whilst using the tools on the stairs.
11. Keep hair, loose clothing, fingers and all parts of the body away from openings and moving parts.

## **Safety Alerts:**

### **To reduce the risk of fire, electric shock, or injury**

1. Do not leave the vacuum unattended when plugged in, unplug from the outlet when not in use and before servicing.
2. To reduce the risk of electric shock, do not use outdoors or on wet surfaces.
3. Use only as described in this manual.
4. Do not use with a damaged cord or plug.
5. Do not run the vacuum cleaner over the cord. Keep the cord away from heated surfaces.
6. Do not unplug by pulling on the cord. To unplug, grasp the plug, not the cord.
7. Do not handle the plug or the vacuum cleaner with wet hands.
8. Turn off all controls before unplugging.

## Electrical Safety

Before switching on, make sure that the voltage of your electricity supply is the same as that indicated on the rating plate. This product is designed to operate on 220 – 240V AC; 50Hz.

Connection to any other power source may damage the unit.

This product may be fitted with a non – rewirable plug. If it is necessary to change the fuse in the plug, the fuse cover must be refitted. If the fuse cover becomes lost or damaged, the plug must not be used until a suitable replacement obtained.

If the plug has to be changed because it is not suitable for your socket, or becomes damaged in any way, it should be cut off and an appropriate plug fitted following the wiring instructions below. This should be carried out by a qualified electrician. The plug removed must be disposed of safely, as insertion into a 13 Amp socket is likely to cause an electrical hazard.

**IMPORTANT – THIS IS A CLASS II APPLIANCE AND DOES NOT REQUIRE AN EARTH CONNECTION.**

### Wiring Instructions

The wires in this mains lead are colored in accordance with the following code:

**Blue = Neutral**

**Brown = Live**

As the colours of the wires in the mains lead of this appliance may not correspond with the coloured markings identifying the terminals in your plug, proceed as follows (refer to the plug wiring diagram).

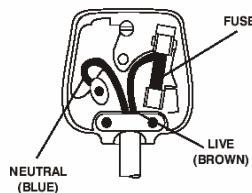

- The wire which is coloured **BLUE** must be connected to the terminal which is marked with the letter **N** or coloured Black.
- The wire which is coloured **BROWN** must be connected to the terminal which is marked with the letter **L** or coloured Red.

If a 13Amp (BS1363) plug is used, a 13Amp (BS1362) fuse must be fitted, or if any other type of plug is used, a 13Amp fuse must be fitted, either in the plug or adaptor, or on the Distribution Board.

## GETTING TO KNOW YOUR BAGLESS CYCLONIC UPRIGHT

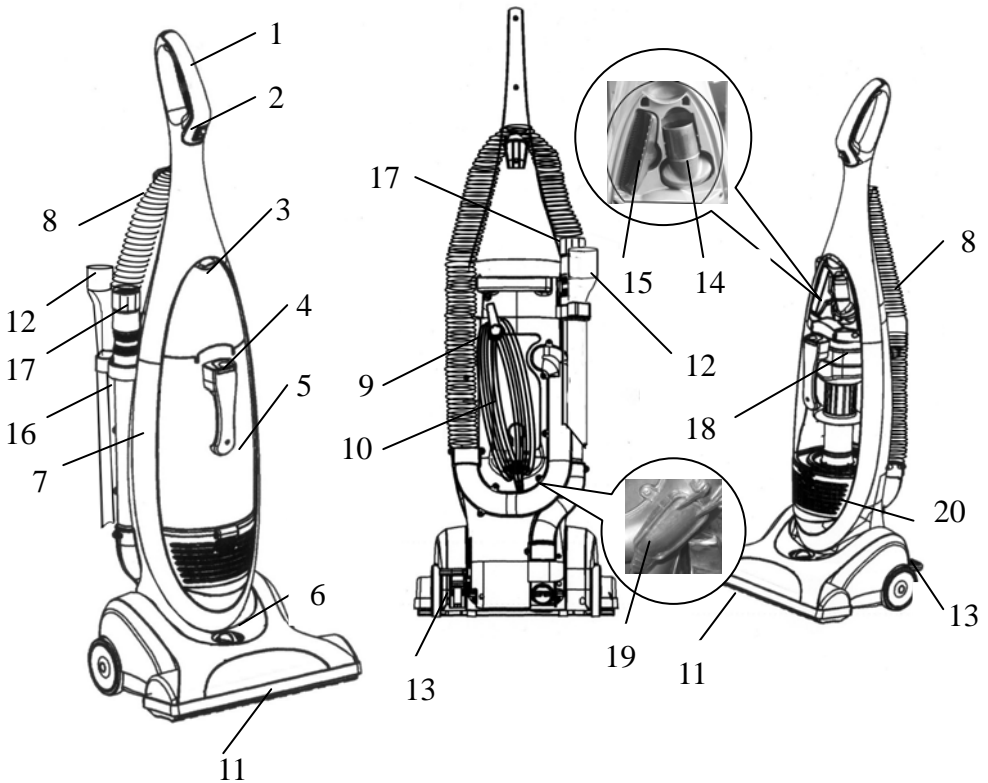

- |                                    |                              |
|------------------------------------|------------------------------|
| 1. Upper Handle                    | 11. Furniture Guard          |
| 2. On/Off Switch                   | 12. Crevice tool             |
| 3. Accessory Cover Release         | 13. Handle Release           |
| 4. Dust tank release               | 14. Small brush              |
| 5. Dust tank                       | 15. Upholstery tool          |
| 6. Carpet Height Adjustment Knob   | 16. Extension tube (x2)      |
| 7. Main body                       | 17. Hose connector           |
| 8. Flexible Hose                   | 18. HEPA Filter Frame        |
| 9. Quick Release Power Cord Holder | 19. Blockage inspection door |
| 10. Power cord                     | 20. Exhaust filter grill     |

# OPERATING INSTRUCTIONS

## Assembling Your Vacuum Cleaner

**Note:** Do not plug the power cord into an electrical outlet until the vacuum is fully assembled.

### Handle Assembly

1. Carefully unpack all components, set aside packaging.
2. Lift the vacuum body to the upright position.
3. Remove the screws (2) that come attached to the body.
4. From the rear of the vacuum, slide the handle into position (with dust-bin removed).
5. Once the handle is in place, secure with the screws (2). (Fig. 1)

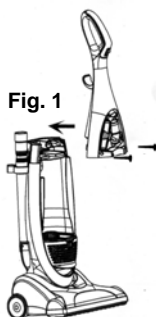

**Caution:** Do not over tighten. Over tightening could strip the screw holes. Do not operate the vacuum without the handle screws in place.

### Cord Assembly

1. Make sure that the quick release cord holder is in the upright position.
2. Remove the wire tie from the power cord.
3. Wrap the cord into place by wrapping it in a clockwise direction around the quick release cord holder and the lower cord holder. (Fig. 2)
4. Turn the quick release cord holder to the left or to the right to unwrap the power cord. (Fig. 2)

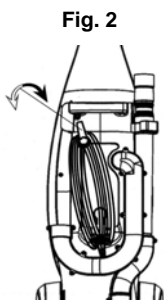

**Warning:** Do not plug in if the power On/Off button is in the "On" position

## Using the Attachments

1. Place the vacuum in its upright position. Make sure that the vacuum cleaner is **NOT** plugged into the electrical outlet when adding or removing accessories.
2. Turn the carpet adjustment knob to the highest position (high pile).
3. Remove the hose connector from the rear of the unit and push in the desired attachment firmly onto the end of the hose.
4. If additional length is required, attach one or both of the extension tubes to the hose and then attach the crevice tool or upholstery brush to the end of the extension tube.

**Warning:** Avoid tipping the vacuum or setting it on furniture, fringed rugs or carpeted stairs while you are using the hose with the attachments. When the vacuum is turned on, the beater brush will continue to rotate. Avoid leaving the vacuum in one place for an extended period of time, particularly on thick carpet.

**Caution:** Do **NOT** pull the vacuum cleaner around the room by the hose as it could tip over and cause damage. When using the attachments, do **NOT** over extend the hose length when reaching. Trying to stretch beyond the hose reach could cause the vacuum to tip over.

### How to Start

1. Turn the quick release cord holder to either side 180° to release the power cord.
2. Plug the power cord into the electrical outlet.
3. Depress the handle release pedal to release the handle.
4. Push the On/Off button to the "On" position to turn the vacuum on.
5. When using the attachments, the vacuum **must** be in the upright position. (Fig. 3)

Fig. 3

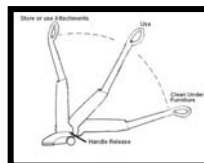

# OPERATING INSTRUCTIONS

## Carpet Height Adjustment

This upright vacuum can be used on multiple types of carpet, bare floors or upholstery with tool attachments.

To select a pile height setting:

1. Turn the vacuum cleaner "Off".
2. Lower the handle to a work position
3. Select the height setting by turning the carpet height adjustment knob to the desired setting. (Fig. 4)



Fig. 4

Suggested Pile Height Setting:

You may need to raise the height of the vacuum to make some jobs easier, such as scatter rugs and longer pile carpets. (Fig. 5) Suggested settings are:

**HIGH:** shag carpet, long pile, plush scatter rugs  
medium to long pile

**LOW:** short to medium pile, bare floors very low  
pile, bare floors

Select the "HIGH" setting when using tool attachments to prevent possible floor damage.

**Attention:** Special care is required when vacuuming certain types of carpet or floor covering. Always check the carpet or floor covering manufacturer's recommended cleaning instructions before vacuuming.



Fig. 5

## Removing & Emptying the Dust-bin

**Warning:** To reduce the risk of electric shock, the power cord must be disconnected before removing the dust-bin, dust-bin filter, changing the filters or performing maintenance/trouble shooting checks.

The "Dust-bin" must be emptied when the dirt level reaches the "FULL" line on the dust-bin. To remove the dust-bin from the vacuum:

1. To remove the dust-bin;  
Press the dust-bin release button whilst grasping the handle and pull the dust-bin away from the vacuum. (Fig. 6)
2. To empty the dust-bin, hold it by the handle over a bin and press the trap door release button to empty. (Fig. 7)

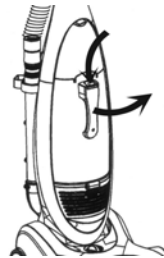
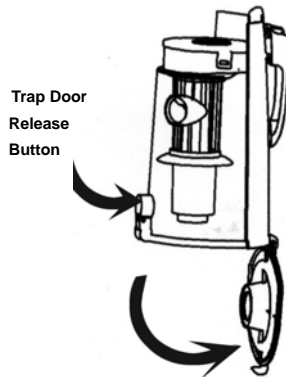

Fig. 6

Fig. 7



# OPERATING INSTRUCTIONS

## Cleaning the HEPA Dust Cup Filter

**IMPORTANT, Please Note:** The Washable "Tap Clean" HEPA Dust-bin Filter will stop most dust particles and airborne allergens from re-entering the air you breathe.

The HEPA Dust-bin Filter will quickly accumulate many fine dust particles within the white filter folds and will eventually reduce your suction power if not cleaned properly. Clean the HEPA Filter after each use as described in this section.

1. To remove the HEPA filter:  
With the dust-bin removed, unclip the filter cover and lift the filter from the dust-bin. (Fig. 9)



Fig. 9

2. Vigorously "Tap Clean" the HEPA dust-bin filter on a hard surface until no more dust is observed falling out. (Fig. 10)

To assist cleaning the HEPA filter pleats you can use the rotating beater. This is positioned on top of the filter.

(Fig. 11)



Fig.10

After tapping clean, the HEPA filter can be rinsed through by running it under a tap in tepid water. (Fig. 12-1)



Fig. 11

We recommend washing the filter once a month or when suction appears reduced.

**Always allow 24 hours** for drying before refitting to the vacuum.



Fig. 12-1

**Please Note:** The white HEPA filter will discolour over time - This is NORMAL and will NOT affect the performance of the filter.

## **To obtain optimum performance:**

Before each use you must ensure the dust-bin is empty and that the HEPA filter is clean and free from dust and hair.

## Cleaning the HEPA Filter Frame

1. Before replacing the HEPA filter:  
Remove the filter frame by placing your hand on the frame from within the dust-bin and twisting clockwise to unlock.

Rinse the frame in lukewarm water by just running it under the tap to remove any dust that has adhered to the frame. (Fig. 12-2) Do **NOT** place in dishwasher.



Fig. 12-2

2. Make sure that the filter frame is completely dry before replacing.
3. Refitting is the opposite procedure to removal. Please ensure the frame locks in position. It will click shut.

## Cleaning the Secondary Filter

1. Underneath the HEPA filter is a secondary filter. This foam filter can be cleaned by washing / rinsing in lukewarm water. (Fig. 13)

We recommend washing it when you are washing / rinsing your HEPA filter.

**Always allow the secondary filter to air dry for 24 hours** before refitting into the vacuum. Never run the vacuum **without** the secondary filter in place.



Fig. 13



# OPERATING INSTRUCTIONS

## Changing & Cleaning the Pre- Motor Filter

**Warning:** To reduce the risk of electric shock, the power cord must be disconnected before removing the dust-bin, dust-bin filter, changing the filters or performing maintenance/trouble shooting checks.

The pre-motor filter is located in the vacuum underneath the dust-bin. Please note that this filter is a washable filter and can be cleaned by rinsing under lukewarm water. Always allow the pre-motor filter to air dry for 24 hours before replacing in the vacuum. Do not use a hair dryer to dry it. Air dry only.

### **To remove the pre-motor filter:**

1. Remove the dust-bin (see page 6).
2. Remove the pre-motor filter and clean by rinsing in lukewarm water.
3. After air drying for 24 hours, replace in the vacuum.

Fig. 14



Pre-motor filter



Exhaust Filter

Fig. 15

## Changing & Cleaning the Exhaust Filter

**Warning:** To reduce the risk of electric shock, the power cord must be disconnected before removing the dust-bin, dust-bin filter, changing the filters or performing maintenance/trouble shooting checks.

The exhaust filter is located on the front of the vacuum below the dust-bin. To remove the exhaust filter, you must first remove the exhaust grill. (fig 14)

1. Check the exhaust filter frequently and clean when dirty.
2. Remove the exhaust filter by pulling down and unclipping the exhaust grill. (see fig 14).

## Changing & Cleaning the Exhaust Filter (cont.)

3. Pull the exhaust filter out. (Fig. 15)
4. Replace the filter when it is visibly solid or when it has stopped absorbing pet odors.

**Never operate the vacuum without ALL the filters in place.**

Fig. 14



Pre-motor filter



Exhaust Filter

Fig. 15

## Cleaning the Dust-bin

**Warning:** To reduce the risk of electric shock, the power cord must be disconnected before removing the dust-bin, dust-bin filter, changing the filters or performing maintenance/trouble shooting checks.

The dust-bin can be washed in lukewarm water. Do not use strong detergents.

Ensure that the dust-bin is fully dry before placing back on the vacuum cleaner.

(Fig. 16)

Do not wash in dishwasher.



Fig. 16

# OPERATING INSTRUCTIONS

## Cleaning & Changing the Belt

**Warning:** To reduce the risk of electric shock, the power cord must be disconnected before removing the dust-bin, dust-bin filter, changing the filters or performing maintenance/trouble shooting checks.

Occasionally the drive belt will require changing, the frequency of this will depend upon the amount of use your vacuum sees.

1. Turn the vacuum "Off" and unplug from the power supply.
2. Lower the handle from the upright position by pressing on the handle release pedal and pull back. Then turn the vacuum over and place on the floor.  
With a screw driver, remove the four screws at the bottom of the power head. (Fig. 20)
4. Undo the screw holding the height adjustment knob. (This screw can be seen by lifting the wheel assembly).

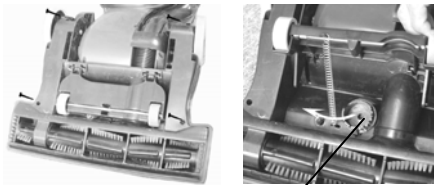

Fig. 20

Height adjustment screw

4. With the vacuum lying down, turn it over and lift off the top cover, starting from the back of the power head. (Fig. 21)

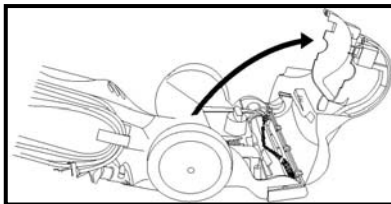

Fig. 21

5. Use a flat bladed screw driver to remove the agitator.
6. Slide the flat head screw driver into the left side of the power head between the agitator and the power head housing and lift. (Fig. 22)

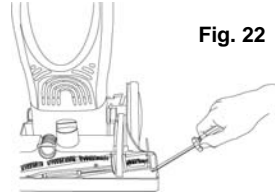

Fig. 22

7. Carefully remove any residue that may exist in the belt area.
8. If the belt has broken, remove any loose pieces before replacing with a new belt.
9. Hold the agitator with your hand. If the belt is still attached to the agitator, there will be tension on it.
10. Carefully lift the left side of the agitator and then the right side.
11. Remove the worn or broken belt from the motor drive shaft.
12. Loop the new belt first over the motor drive shaft and then over the agitator pulley on the agitator. (Fig. 23)

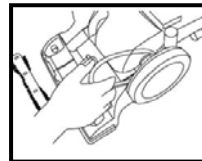

Fig. 23

13. Insert the right side of the agitator first by placing the end cap down into the slot and then do the same with the left side. Press firmly to make sure that each end is completely inserted.
14. Check to make sure that the belt is centered on the pulley and that the agitator turns freely.
15. Refit the top cover and replace the screws. Firstly secure the screws at the back of the floor head and then the remaining front ones. Don't forget to secure the height adjustment screw.

# OPERATING INSTRUCTIONS

## **Motor Thermostat**

**Important:** This unit is equipped with a motor protective thermostat. If for some reason the vacuum cleaner should overheat, the thermostat will automatically turn the unit off. Should this occur:

- Push the On/Off button once.
- Disconnect the plug from the power source.
- Check the reason for overheating (i.e. clogged hose or filter)
- If clogged hose or filter, remove the blockage and clean/ replace the filters.
- Wait at least 45 minutes before attempting to reuse the vacuum.
- After the unit has cooled down for 45 minutes, plug in the cleaner and push the On/Off button. The vacuum should start again.

## PROBLEM SOLVING

This appliance was inspected thoroughly and was in good operating condition when it was shipped from the factory. If a minor problem occurs, it can usually be solved quite easily. Therefore, this checklist is provided for your convenience.

PROBLEM	POSSIBLE CAUSE	POSSIBLE
Cleaner Won't Run	<ol style="list-style-type: none"> <li>1. Not properly plugged into outlet.</li> <li>2. No electricity in wall outlet</li> <li>3. On/Off switch not turned on.</li> <li>4. Motor thermostat tripped.</li> <li>5. Blown fuse/tripped breaker.</li> </ol>	<ol style="list-style-type: none"> <li>1. Plug in firmly.</li> <li>2. Reset the circuit breaker or replace the fuse.</li> <li>3. Push on/off switch to on.</li> <li>4. Remove blockage and allow the vacuum to cool down.</li> <li>5. Check fuse or breaker &amp; reset.</li> </ol>
Cleaner Won't Pick Up	<ol style="list-style-type: none"> <li>1. Full or clogged dust-bin.</li> <li>2. Wrong pile height setting.</li> <li>3. Clogged nozzle or dust inlet port.</li> <li>4. Blocked hose – Check behind inspection door (No 19 page 4).</li> <li>5. Broken belt.</li> <li>6. Hose not inserted fully.</li> <li>7. Dirty filters.</li> <li>8. HEPA filter needs cleaning or replacing.</li> </ol>	<ol style="list-style-type: none"> <li>1. Clean dust-bin.</li> <li>2. Adjust setting.</li> <li>3. Remove obstruction.</li> <li>4. Remove obstruction.</li> <li>5. Replace belt.</li> <li>6. Push hose in securely.</li> <li>7. Clean / change filters</li> <li>8. Clean or replace HEPA Filter.</li> </ol>
Vacuum difficult to move or push over the carpet	<ol style="list-style-type: none"> <li>1. Wrong pile height setting.</li> </ol>	<ol style="list-style-type: none"> <li>1. Adjust setting.</li> </ol>
Agitator Does Not Turn	<ol style="list-style-type: none"> <li>1. Broken drive belt</li> <li>2. Belt(s) installed incorrectly.</li> </ol>	<ol style="list-style-type: none"> <li>1. Replace drive belt.</li> <li>2. Check belt and agitator bar.</li> </ol>
Air Flow Restricted With Attachment Usage Sound Changes	<ol style="list-style-type: none"> <li>1. Attachment used restricts air flow.</li> <li>2. Debris clogging air path.</li> </ol>	<ol style="list-style-type: none"> <li>1. Check attachment.</li> <li>2. Remove obstruction.</li> </ol>

## SPARES & SERVICE

### Service

- Should the vacuum cleaner malfunctioning or the power cord is damaged in any way, don't use the vacuum cleaner. The vacuum cleaner must be repaired by a qualified service agent.
- If you have any problems with your vacuum cleaner, please call the Swan helpline: 01733 404703.

### Available Spares

SU3020/01	Hose
SU3020/02	Belt
SU3020/03	Beater Bar
SU3020/04	Extension Tubes
SU3020/05	Upholstery Tool
SU3020/06	Crevice Tool
SU3020/07	Dusting Brush
SU3021/08	Dustbin & Lid
SU3020/09	Debris Screen (not supplied with filter kit)
SU3021/51	Filter Kit

**SWAN VACUUM HELPLINE: PLEASE CALL 01733 404703**

**SWAN VACUUM SPARE PARTS: PLEASE CALL 01733 404709**

**Calling from outside the UK please call - 00 44 1733 404703**

## WASTE ELECTRICAL RECYCLING

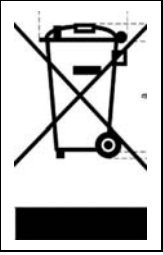

This symbol indicates that this product is classed as Electrical or Electronic Equipment and should not be disposed of with other household waste.

The Waste Electrical and Electronic Equipment (WEEE) Directive has been introduced across the European Union:

- to recycle waste electrical products using the best available recovery and recycling techniques in order to minimise the impact on the environment
- to treat any hazardous substances and
- to avoid increasing landfill.

WEEE product should be disposed of by handing it over at a designated collection point.

**For more information about where you can drop off your waste product for recycling please contact your local authority.**

